

HORSE CARRIAGE WAGON

370'02

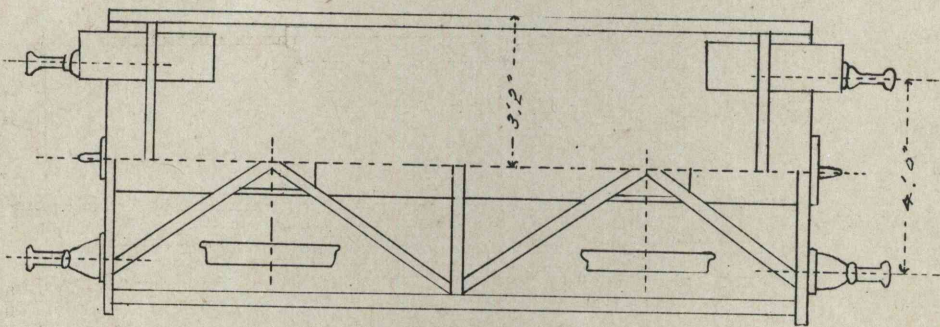

OPEN WAGON

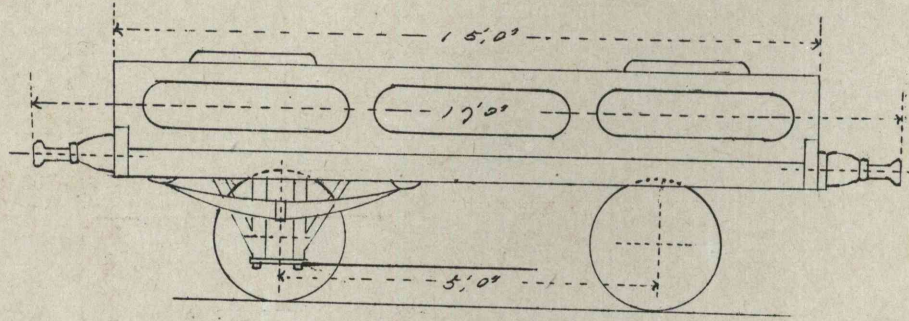
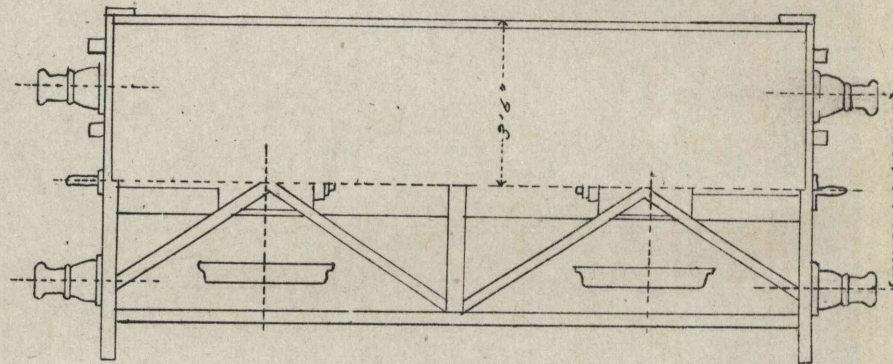
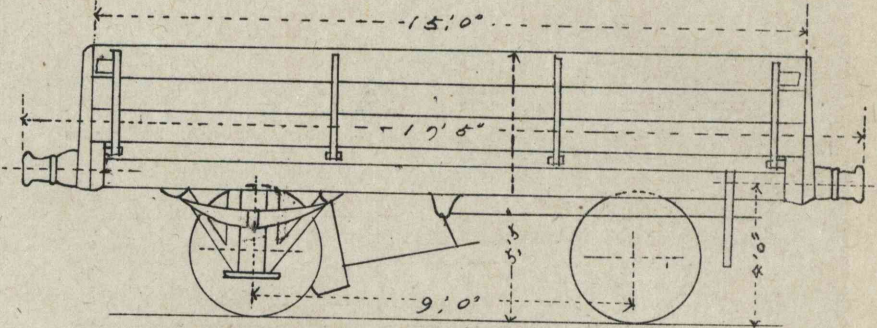

FISH WAGON

470'02

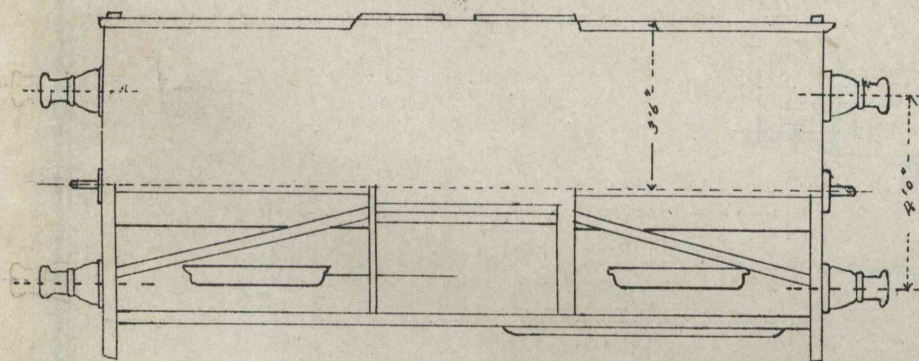
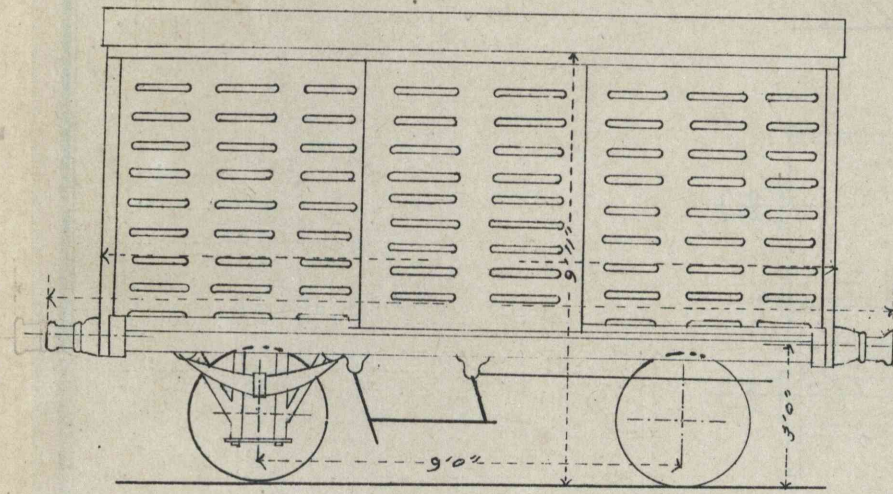

COVERED GOODS WAGON

470'02

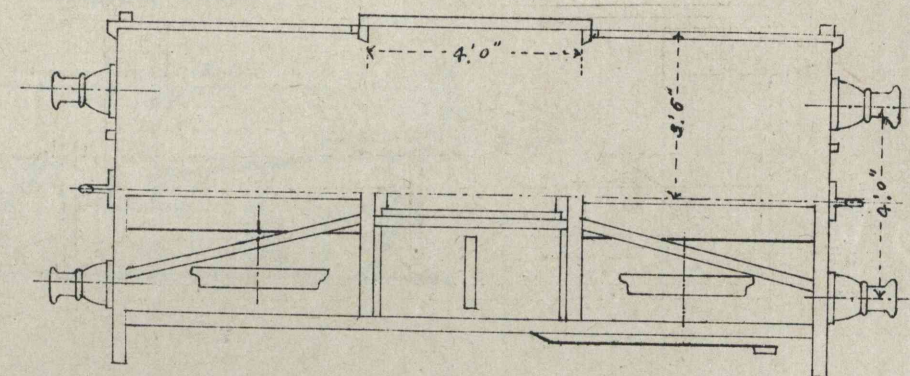
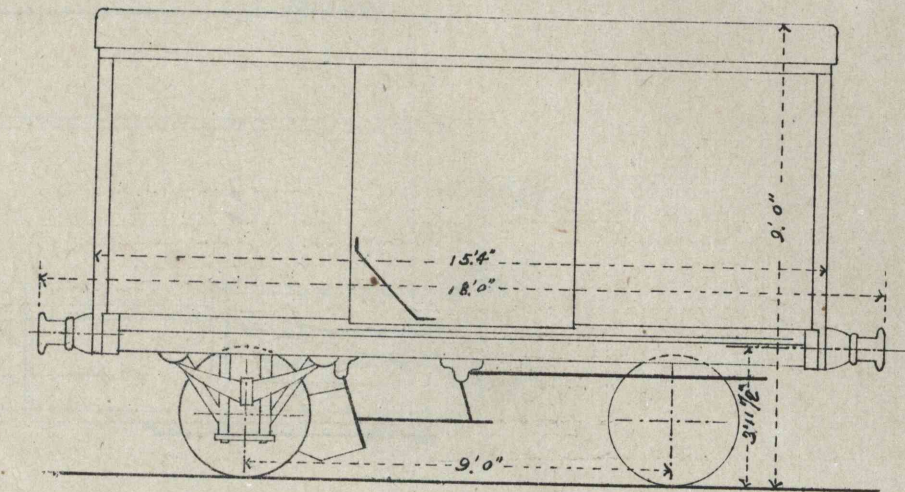

HORSE BOX

477'02

HORSE 2

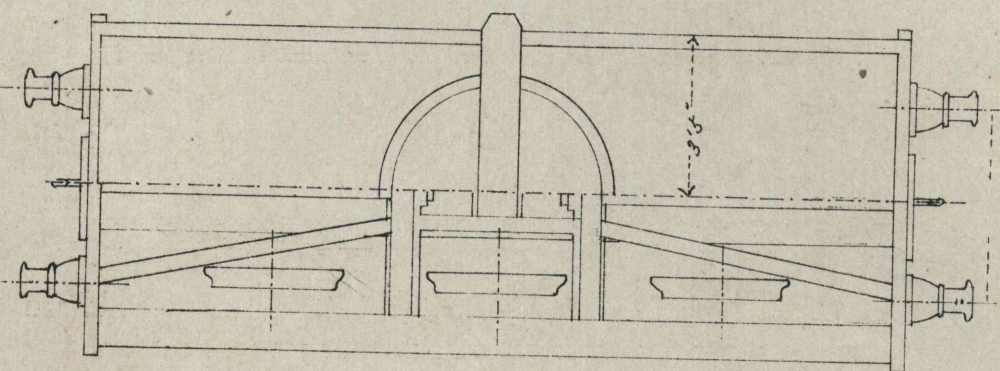
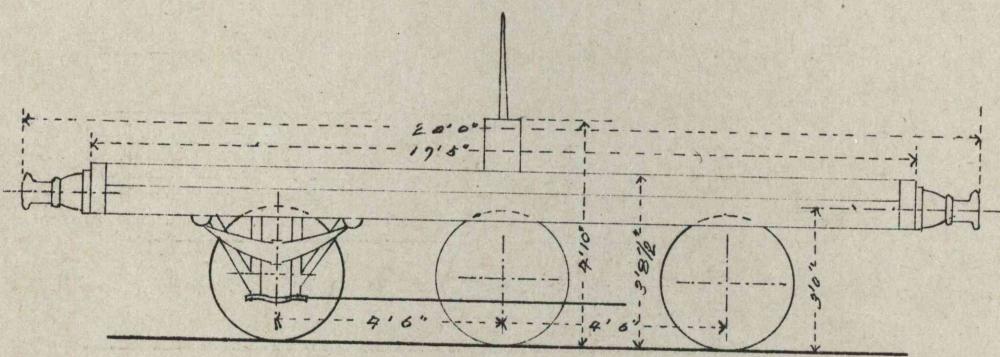

GOODS AND BRAKE VAN

477'02

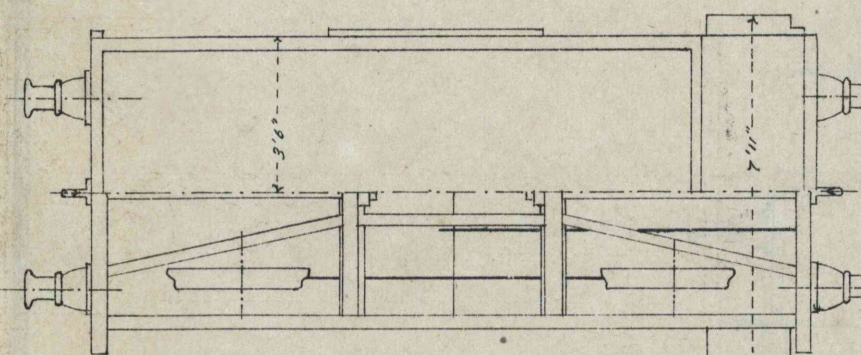
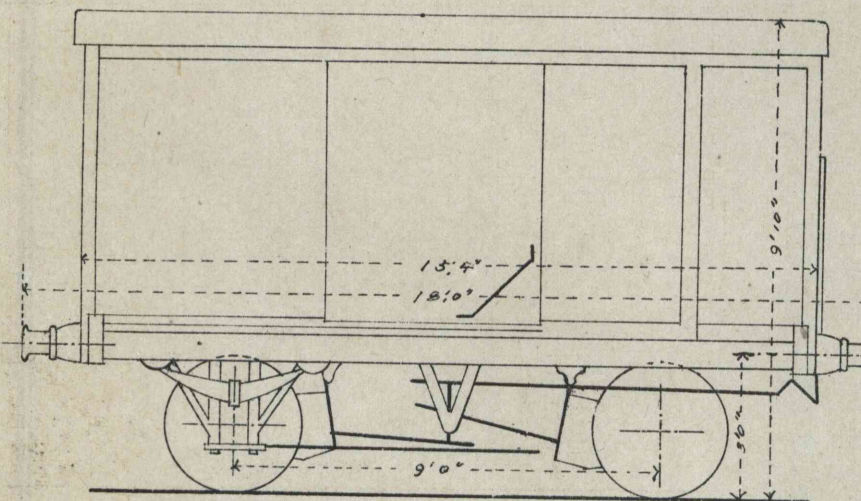
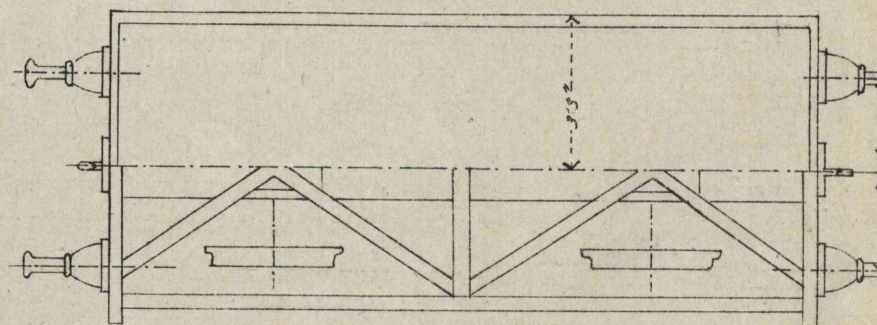
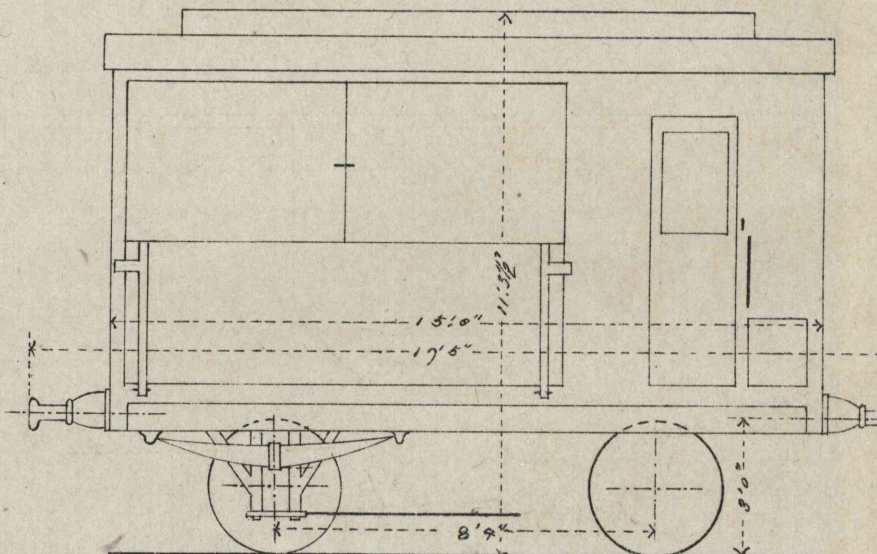

BALLAST WAGON

370'02

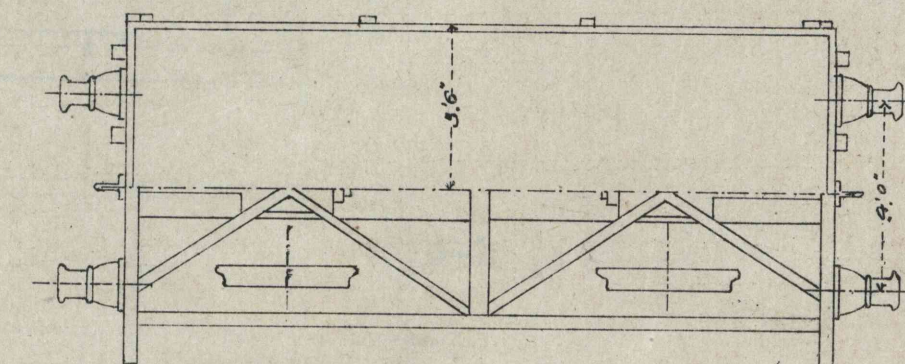
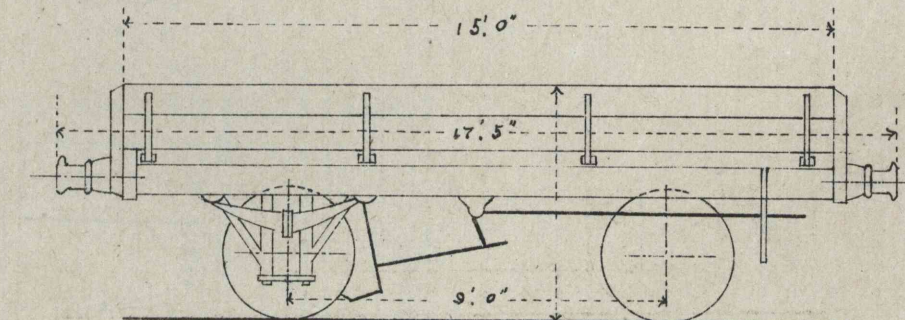

R. uchida